



ورشة السراج المنير للحداذة  
ALSIRAJ ALMUNIR METAL FABRICATION WORKS

متخصصون في مجال أعمدة الإنارة الديكورية  
مجموعه عبد الله سعود العرجاني للتجارة

ABDULLAH SAUD ALARJANI TRADING GROUP



info@alsirajalmunir.com  
www.alsirajalmunir.com



+966 502 86 3503  
+966 502 21 1015

# مقدمة

تأسست مجموعة عبدالله سعود العرجاني في بداية عام 2013 وتركز نشاط المجموعة على استيراد مستلزمات الانارة الخارجية من مواسير انارة الشوارع والكشاف الخارجية الديكورية واكسسوارات الإضاءة وتحافظ المؤسسة منذ تأسيسها على المستوى العالي من الجودة و كفاءة الطاقة على كافة منتجاتها المستوردة حسب متطلبات السوق المحلي وهيئة المواصفات والمقاييس العربية السعودية وتماشيا مع تطورات العصر الحديث واكبت المؤسسة رؤية المملكة

عبر انشاء فرعها ورشة السراج المنير واشراكها رحلة التحول لعكس طموحات وقدرات بلادنا وتحقيق رؤية 2030 على اكمل وجه من خلال توفير الحلول في مجال انارة الشوارع والطرق وتلبية الطلب المستمر على منتجات المؤسسة بأعلى معايير الجودة والمواصفات وتمكين القوى العاملة من ذوي المهارات العالية والخبرات الطويلة في تحقيق التزامنا تجاه عملائنا بالمواعيد والمصداقية في العمل

# القائمة

## التفاصيل

- 1 العنوان و الموقع
- 2 كشافات إنارة LED
- 3 أعمدة إنارة مخروطية
- 4 غاليري (فوتوغرافي)
- 5 مخططات لأعمدة الإنارة الديكورية
- 6 تعمل بالطاقة الشمسية LED كشافات
- 7 إنارة حدائق

مجموعة عبدالله سعود العرجاني للتجارة  
ورشة السراج المنير للحداة  
متخصصون في تصنيع أعمدة الانارة الديكورية

شركاؤكم في النجاح  
الإدارة الرئيسية

الرياض ، المملكة العربية السعودية  
مخرج 18 ، السلي ، المنطقة الصناعية شارع اسطنبول



ورشة السراج المنير للحداة  
ALSIRAJ ALMUNIR METAL FABRICATION WORKS



+966 502 86 3503

+966 502 21 1015



**ABDULLAH SAUD ALARJANI TRADING GROUP**

E-mail:

[info@alsirajalmunir.com](mailto:info@alsirajalmunir.com)

[www.alsirajalmunir.com](http://www.alsirajalmunir.com)





كشافات إنارة ليد مع شهادات ساسو

**IP66**

**Product Specification**

**General Requirement**

Product Name	200W LED Street Light
Size (MM)	900*320*150
Weight (KG)	8.9
Body Material	Die Cast Aluminum
Diffuser Material	Tempered Glass
Power	200W
Color Temp.	4000-6500K
Warranty	5 Years
After sales service	10 Years
Power Factor	0.98
Voltage	110-270V
CRI	≥70

**Driver**

Input Voltage	110-277V
Output Frequency	50/60Hz
Power Factor	0.98
Driver Brand	Philips, Dimmable

**LED Chip**

Product Specification	Lumileds 3030
Lumen	140 LM/W

**200W LED STREET LIGHT**



**LED Street Light**

**200W**



**Product Feature:**

- Unique and convenient design of the module
- Philips chip, high stability, high CRI, high lumen
- Philips dimmable and high efficiency driver
- The lens adopts anti-glare design to minimize the glare

Test: 0.220.0V 2:0.9171A P:100.1W PF:0.9816 Freq:50.00Hz Lamp Flux:23685.1lm 2m		
NAME: Led Street Light	TYPE: --	MODEL: --
SPEC: 200W	DCM: --	SERIAL No.: P7850116011-01
	SR: #30mm	Shielding Angle: --

DATA OF LAMP		PHOTOMETRIC DATA REF: 119.59 lm/W			
MODEL		I <sub>max</sub> (cd)	12795	S/MR (C0/180)	2.33
NOMINAL POWER (W)	--	LOR (h)	100.0	S/MR (C90/270)	0.94
RATED VOLTAGE (V)	--	TOTAL FLUX (lm)	23685	η <sub>UP, DN</sub> (C0-180)	6.4, 64.0
NOMINAL FLUX (lm)	23685.1	CIE CLASS	DIRECT	η <sub>UP, DN</sub> (C180-360)	0.3, 44.0
LAMPS INSIDE	1	η <sub>up</sub> (h)	1.1	CIBBE SR <sub>0</sub> NOM	1.25
TEST VOLTAGE (V)	--	η <sub>down</sub> (h)	90.9	CIBBE SR <sub>0</sub> MAX	1.35

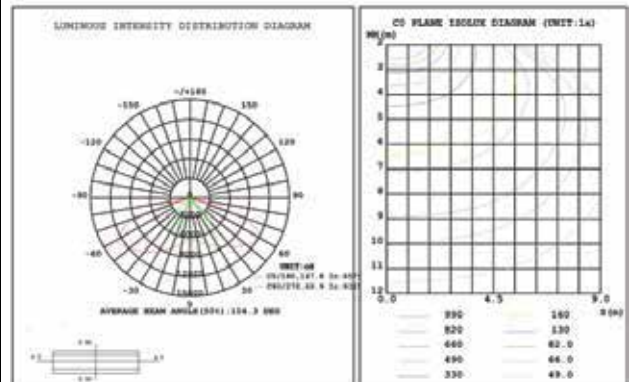

S  
f



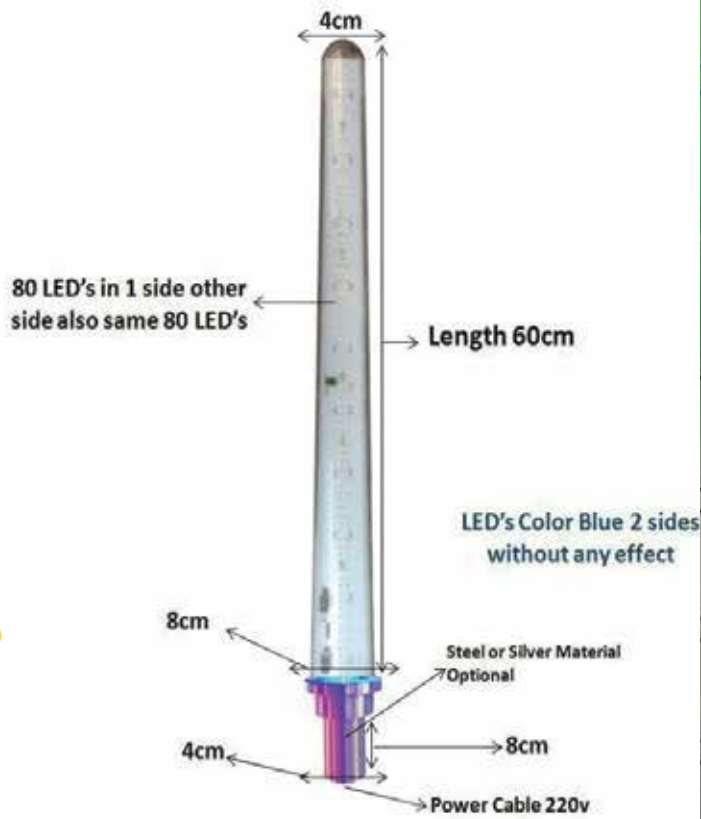





**LIGHTS**





Size:720\*360\*100mm





الهيئة السعودية للمواصفات والمقاييس والجودة  
Saudi Standards, Metrology and Quality Org.

بطاقة كفاءة الطاقة  
ENERGY EFFICIENCY LABEL



LIGHTING

الإضاءة

STREET LIGHTING

إضاءة الشوارع

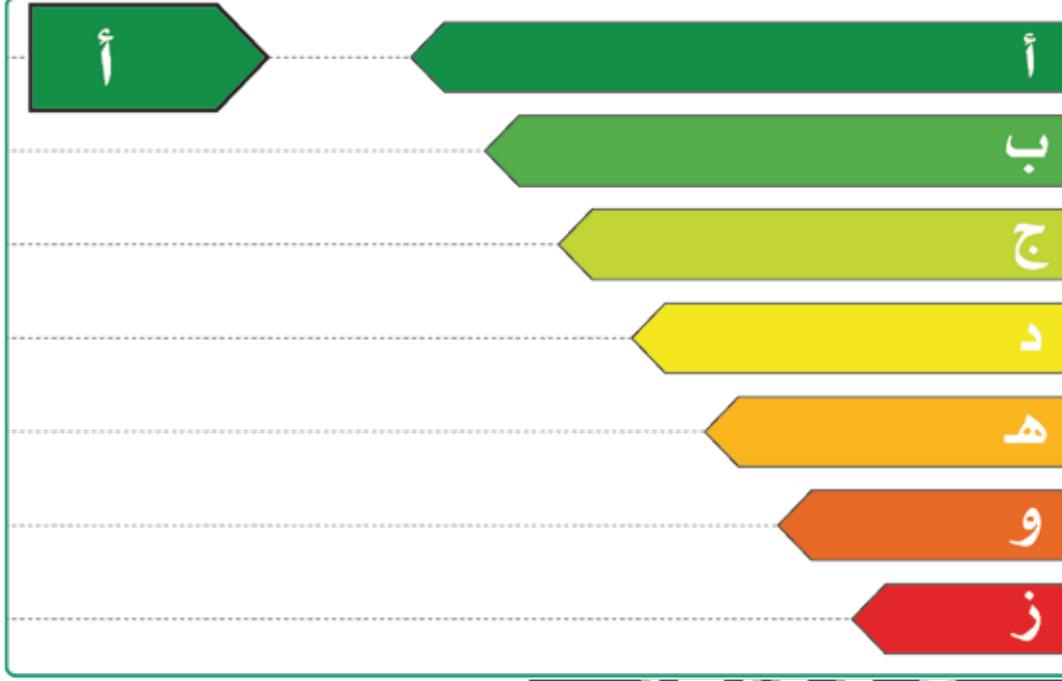

BRAND NAME العلامة التجارية

MINGJIAN

MADE IN بلد الصنع

China



MODEL NUMBER رقم الطراز

MJ-200W-B

LIGHTING TYPE نوع الإضاءة

Street Light

E34185/2020

رقم التسجيل  
REGISTRATION NO

STANDARD REFERENCE NO SASO 2927:2019

الرقم المرجعي للمواصفة

إزالة أو تغطية أو العبث بهذه البطاقة قبل البيع يجعلك عرضة للمسؤولية النظامية  
Removing, covering or altering this label before sale can subject you to legal liability

# Certificate For Energy Efficiency Label



الهيئة السعودية للمواصفات والمقاييس والجودة  
Saudi Standards, Metrology and Quality Org.

## The Saudi Standards, Metrology and Quality Org. (SASO)

has certified : **Zhongshan Mingjian Lighting Co., Ltd.** to use the energy efficiency certificate according to **SASO 2927:2019**, for the **Lighting Part3** product and technology **LED\_LUMINAIRE\_STREET\_LIGHT** :-

Type of Product	Brand name	Model's number	Rated Power (W)	Rated Lumen Flux (lm/w)	Driver Efficiency ( $\eta$ )	Factory Country	Color Temperature (K)	Classification
Luminaire	MINGJIAN	MJ-200W-B	200	24000	NA	China	4000	A
Control Gear	Philips	Xi LP 220W 0.3-1.05A S1 TWE I230	200	NA	93	Netherlands	NA	

\* Expiry Date: **1443-07-23 AH, 24-Feb-2022 AD**

This certificate is subject during its validation to the related Rules & Regulations of the Kingdom of Saudi Arabia, and any Instructions or Amendments issued by SASO.



Application No: E34185/2020

License No: LP2122034185

# IECEE



الهيئة السعودية للمواصفات والمقاييس والجودة  
Saudi Standards, Metrology and Quality Org.

## شهادة اعتراف بشهادة (IECEE) Recognition Certificate of (IECEE) Certificate الرقم: 20190018263 No.:

بناء على شهادة الاختبار وتقرير الاختبار الموضحة بياناتها أدناه، وكون الهيئة السعودية للمواصفات والمقاييس والجودة هي جهاز منح الشهادات الوطني وعضو مشارك في الهيئة الدولية لتقويم المطابقة ومنح الشهادات للأجهزة والمكونات الكهروتقنية (IECEE)، فقد تم منح هذه الشهادة اعترافاً بأن المنتج الموضح بياناته أدناه مطابق للمواصفات القياسية والفروقات الوطنية ذات العلاقة.

According to the test certificate and test report that their information is mentioned below, and as Saudi Standards, Metrology and Quality Organization (SASO) is the national certification body and a participant member in IEC System of Conformity Assessment Schemes for Electro-technical Equipment and Components (IECEE). Therefore, this certificate is granted as a recognition that the below mentioned product is conformed to the related national standards and differences.

Company name:	Danyang Tonly Lighting Co., Ltd.	اسم الشركة المصنعة:
Technical requirements/ Standard references:	SASO IEC 60598-2-3; SASO IEC 60598-1	المتطلبات الفنية/القياسية:
The issuing body of test certificate:	Eurofins Product Service GmbH	جهة إصدار شهادة الاختبار:
DE-6-G6190434	رقم شهادة الاختبار: CB test certificate No. EFSH19071883-IE-01-L01	رقم تقرير الاختبار: Test report No.

### بيانات المنتج Product Information

Product name:	Lighting and its parts (required SLS Certificate)	اسم المنتج:
Technology name:	LED	اسم التقنية:
Trade mark name:	S	اسم العلامة التجارية:
Additional information:	Abdullah Saud Mohammed AlArjani Trading Est.	معلومات إضافية:

Expiry date: 08/09/2020 تاريخ الانتهاء:

لا تستعمل هذه الشهادة إلا مع هذا المنتج فقط دون أدنى مسؤولية على الهيئة في ذلك  
This certificate is used only for this product without any responsibility on the side of SASO towards others rights



www.saso.gov.sa  
This is an electronic certificate and does not require stamp and signature.  
Visit SASO website (www.saso.gov.sa) to verify this certification.  
Any changes or modification on this certificate will affect its validity.  
P.O.Box 3437 Riyadh 11471 KSA  
Tel: 920009085 Fax: +966114520086

تخضع هذه الشهادة خلال مدة سريانها للأنظمة واللوائح ذات العلاقة في المملكة العربية السعودية وأي تعديلات تصدرها الهيئة.  
هذه الشهادة صادرة إلكترونيًا ولا تحتاج إلى ختم وتوقيع.  
لتأكد من صحة هذه الشهادة يرجى زيارة موقعنا على الإنترنت  
WWW.SASO.GOV.SA  
أي كتمان أو تغيير في هذه الشهادة يُلغى.  
ص. ب 3437 الرياض 11471 المملكة العربية السعودية  
هاتف: +966114520086 فاكس: 920009085

٧  
٨  
٩  
١٠  
١١  
١٢

**Certificate**  
For  
**Energy Efficiency Label**



**The Saudi Standards, Metrology and Quality Org. (SASO)**

has certified : **Danyang Tonly Lighting Co., Ltd.**

to use the energy efficiency label According to SASO 2902:2018, for the following product:-

The Product	Model's number	Brand name	Classification	Licence number
Lights Part 2	TLST001	S		LP2071906135

\* Expiry Date: **1442-01-02 AH, 21-Aug-2020 AD**

This certificate is subject during its validation to the related Rules & Regulations of the Kingdom of Saudi Arabia, and any Instructions or Amendments issued by SASO.



Application No: E06135/2019

+966 11 2529999



شهادة مطابقة للمنتجات الخاضعة للوائح  
**Certificate of conformity for regulated products**



We, the Saudi Standards, Metrology and Quality Organization, certify that the product described below is in accordance with the relevant technical regulations:

Certificate Number	IECEE-19-037828	Issue Date	12/09/2019	Expiry Date	08/09/2020
Certificate Type	IECEE Certificate	IECEE Certificate Issuer	20190018263		
Commercial Registration No.	1011136022	Commercial Registration No. of IECEE Certificate holder	1011136022		
Establishment Address	الخرج الصناعية الجديدة العام 122 123				
Product and Manufacturer Data					
Model type	TLST001, TLST002	Trade Mark	S		
Product Name	LED STREET LIGHT				
Product Description					
Country of origin	China				
HS Code	940540100001				
Technical Regulation	GCC Technical Regulation for Low Voltage Electrical Equipment and Appliances				
Manufacturer name	Danyang Tonly Lighting Co., Ltd				
Manufacturer Address					

Deputy Governor Signature

Saudi Standards, Metrology and Quality Organization Stamp



05/08/2020 07:44

**Certificate**  
For  
**Energy Efficiency Label**



المعهد السعودي للمواصفات والمقاييس والقياس  
Saudi Standards, Metrology and Quality Org.

**The Saudi Standards, Metrology and Quality Org. (SASO)**

has certified : **Danyang Tonly Lighting Co., Ltd.**

to use the energy efficiency label According to SASO 2902:2018, for the following product:-

The Product	Model's number	Brand name	Classification	Licence number
Lights Part 2	TLST002	S		LP2081906136

\* Expiry Date: **1442-01-06 AH, 25-Aug-2020 AD**

This certificate is subject during its validation to the related Rules & Regulations of the Kingdom of Saudi Arabia, and any Instructions or Amendments issued by SASO.



Application No: E06136/2019

+966 11 2529999

**شهادة مطابقة إرسالية للمنتجات المستوردة**  
**Shipment Conformity certificate for imported products**



مؤسسة عبدالله سعود محمد العرجاني للتجارة ( )  
نكر والتعهد نحن ( )  
الشراعية السعودية والأولاح الفنية ذات العلاقة : ونعهد بتوفير أي ملفات فنية للمنتج نظميها الهيئة السعودية للمواصفات والمقاييس والجودة أو من يمثلها كخفا ، وفي حال تبين عدم صحة ذلك التحمل جميع التبعات  
التجارية المترتبة على ذلك

Certificate Number	CN-20-0201577	Issue Date	11/08/2020
Certificate Type	Shipment Conformity Certificate for Imported Products	Commercial Registration No.	1011136022
Establishment Address	الخرج الصناعية الجديدة العام 123 123	Shipment country	China
Product Certificate No.	IECEE-20-277066		

Product and Manufacturer Data	
Model type	TLST002
Product Name	LED STREET LIGHT
Product Description	
Country of origin	China
Production Date	
HS Code	940540100001
Technical Regulation	GCC Technical Regulation for Low Voltage Electrical Equipment and Appliances
Manufacturer name	Danyang Tonly Lighting Co., Ltd
Manufacturer Address	
Exporter name	OIB DANYANG TONLY LIGHTING CO., LTD.
Exporter Address	ZHULI INDUSTRIAL PARK,FANGXIAN TOWN,DANYANG CITY,CHINA



11/08/2020 03:55







الهيئة السعودية للمواصفات والمقاييس والجودة  
Saudi Standards, Metrology and Quality Org.

ملحق الشهادة

Appendix

Company Name

Danyang Tonly Lighting Co., Ltd.

اسم الشركة

Trade Mark Name

LED

اسم العلامة  
التجارية

08/09/2020

تاريخ انتهاء الشهادة  
Certificate Expiration date

20190018263

رقم الشهادة  
Certificate Number :

رقم التسلسل Serial No	رقم الطراز Model Number	رقم شهادة كفاءة الطاقة Energy Efficiency Certificate Number
1	TLST001	LP2071906135
2	TLST002	LP2081906136

**IEC SYSTEM FOR MUTUAL RECOGNITION OF TEST CERTIFICATES FOR ELECTRICAL EQUIPMENT (IECEE)  
CB SCHEME**

**CB TEST CERTIFICATE**

Product	LED Street Light
Name and address of the applicant	Danyang Tonly Lighting Co., Ltd. Zhuli Industrial Park, Fangxian Town, Danyang, Jiangsu China
Name and address of the manufacturer	Danyang Tonly Lighting Co., Ltd. Zhuli Industrial Park, Fangxian Town, Danyang, Jiangsu China
Name and address of the factory	Danyang Tonly Lighting Co., Ltd. Zhuli Industrial Park, Fangxian Town, Danyang, Jiangsu China
<small>Note: If there are other factories, please report on page 2ff.</small>	
Ratings and principal characteristics	220-240V~, 50/60Hz, 20W, IP66, Class II
Trademark (if any)	
Customer Test Facility (CTF) Stage used	1.
Model / Type Ref.	TLST001; TLST002
Additional information (if necessary may also be reported on page 2ff.)	
A sample of the product was tested and found to be in conformity with	IEC 60598-2-3:2002 IEC 60598-2-3:2002/AMD1:2011 IEC 60598-1:2014 IEC 60598-1:2014/AMD1:2017 EFSH19071883-IE-01-L01
As shown in the Test Report Ref. No. which forms part of this Certificate	

eurolfins

This CB Test Certificate is issued by the National Certification Body

**eurolfins** Eurofins Product Service GmbH  
Storkower Strasse 38c  
D-15526 Reichenwalde b. Berlin  
Germany

Date: 2019-07-23

Signature: Forest Yi



شهادة مطابقة إرسالية للمنتجات المستوردة  
Shipment Conformity certificate for imported products



نقر وتنفهذ نحن (مؤسسة عبدالله سعود محمد العرجاني للتجارة) بأن جميع بيانات المنتجات الموجودة في طلب الإرسالية صحيحة ، وأن المنتجات مطابقة للمواصفات القياسية السعودية واللوائح الفنية ذات العلاقة ، وتنفهذ بتوفير أي ملفات فنية للمنتج نطلبها الهيئة السعودية للمواصفات والمقاييس والجودة أو من يمثلها لاحقاً ، وفي حال تبين عدم صحة ذلك التحمل جميع الأعباء النظامية المترتبة على ذلك

Certificate Number	CN-20-0201577	Issue Date	11/08/2020
Certificate Type	Shipment Conformity Certificate for Imported Products	Commercial Registration No	1011136022
Establishment Address	الخرج الصناعية الجديدة العام 123 122	Shipment country	China
Product Certificate No	IECEE-20-277066		

Product and Manufacturer Data			
Model type	TLST002	Trade Mark	S
Product Name	LED STREET LIGHT		
Product Description			
Country of origin	China		
Production Date			
HS Code	940540100001		
Technical Regulation	GCC Technical Regulation for Low Voltage Electrical Equipment and Appliances		
Manufacturer name	Danyang Tonly Lighting Co., Ltd		
Manufacturer Address			
Exporter name	O/B DANYANG TONLY LIGHTING CO., LTD.	Exporter Address	ZHULI INDUSTRIAL PARK,FANGXIAN TOWN,DANYANG CITY,CHINA



11/08/2020 03:55



شهادة مطابقة إرسالية للمنتجات المستوردة  
Shipment Conformity certificate for imported products



نقر وتنفهذ نحن (مؤسسة عبدالله سعود محمد العرجاني للتجارة) بأن جميع بيانات المنتجات الموجودة في طلب الإرسالية صحيحة ، وأن المنتجات مطابقة للمواصفات القياسية السعودية واللوائح الفنية ذات العلاقة ، وتنفهذ بتوفير أي ملفات فنية للمنتج نطلبها الهيئة السعودية للمواصفات والمقاييس والجودة أو من يمثلها لاحقاً ، وفي حال تبين عدم صحة ذلك التحمل جميع الأعباء النظامية المترتبة على ذلك

Certificate Number	CN-20-0201577	Issue Date	11/08/2020
Certificate Type	Shipment Conformity Certificate for Imported Products	Commercial Registration No	1011136022
Establishment Address	الخرج الصناعية الجديدة العام 123 122	Shipment country	China
Product Certificate No	IECEE-20-277067		

Product and Manufacturer Data			
Model type	TLST001	Trade Mark	S
Product Name	LED STREET LIGHT		
Product Description			
Country of origin	China		
Production Date			
HS Code	940540100001		
Technical Regulation	GCC Technical Regulation for Low Voltage Electrical Equipment and Appliances		
Manufacturer name	Danyang Tonly Lighting Co., Ltd		
Manufacturer Address			
Exporter name	O/B DANYANG TONLY LIGHTING CO., LTD.	Exporter Address	ZHULI INDUSTRIAL PARK,FANGXIAN TOWN,DANYANG CITY,CHINA



11/08/2020 03:55



Certificate Number	CN-20-0201577	HS Code	940540100001
Product Name	LED STREET LIGHT	Model type	TLST002
Quantity	3060	Unit	U ( JEU / PACK )

Product invoices supplement:

Invoice number	Invoice Date	The amount of the item on the invoice	Invoice Currency
TL1901	29/07/2020	15,912	US Dollar



Certificate Number	CN-20-0201577	HS Code	940540100001
Product Name	LED STREET LIGHT	Model type	TLST001
Quantity	6940	Unit	U ( JEU / PACK )

Product invoices supplement:

Invoice number	Invoice Date	The amount of the item on the invoice	Invoice Currency
TL1901	29/07/2020	36,088	US Dollar



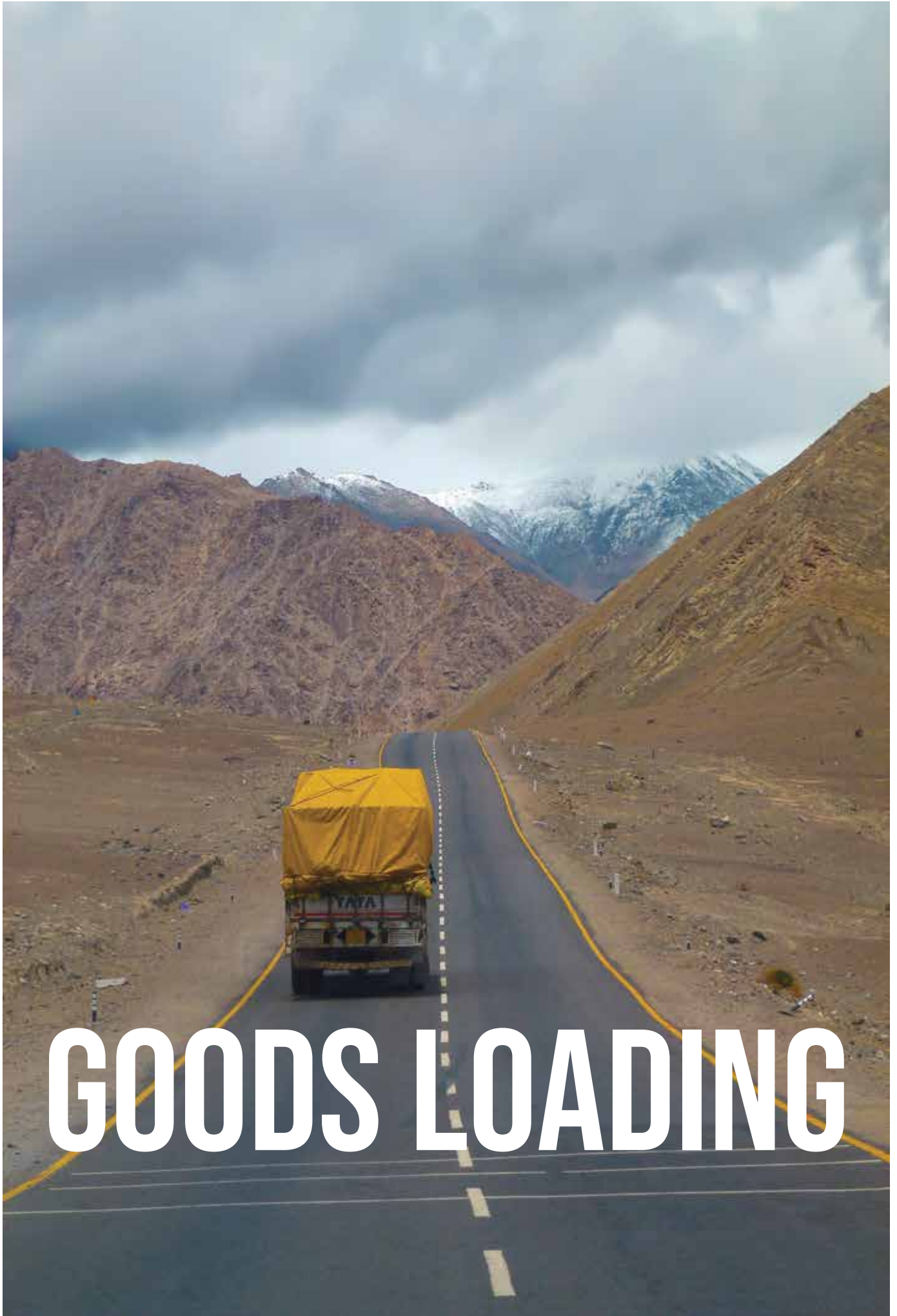

# GOODS LOADING





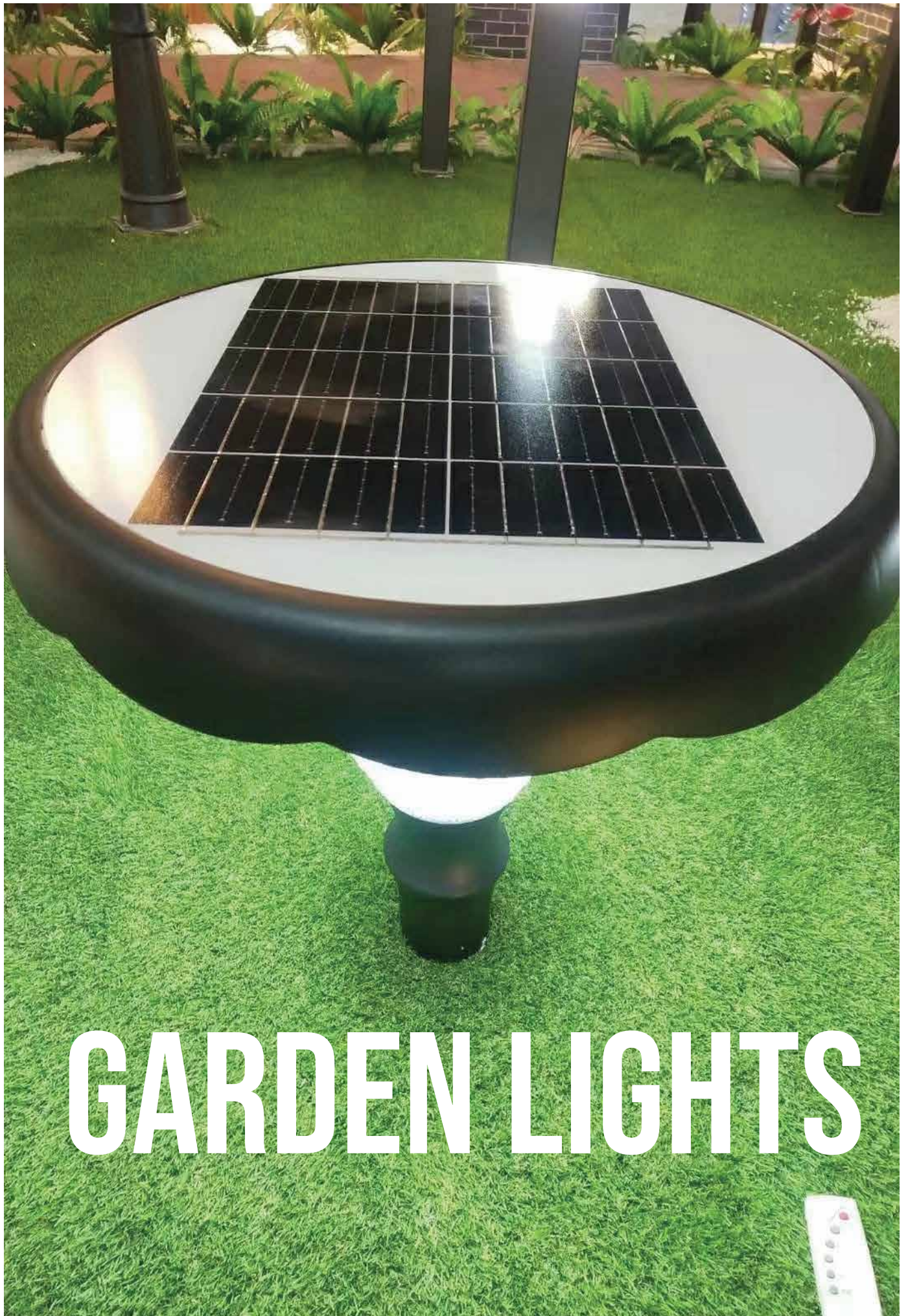

# GARDEN LIGHTS











**DRAWINGS**

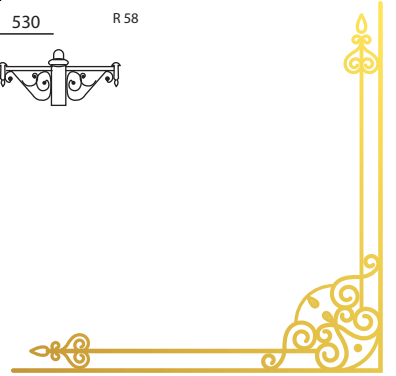
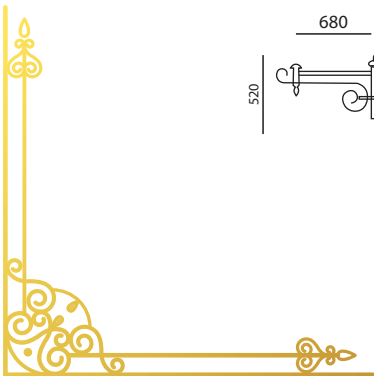
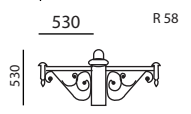
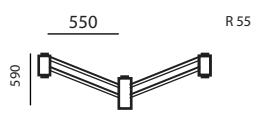
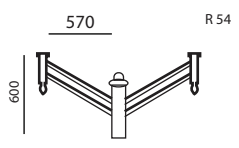
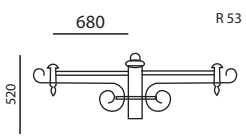
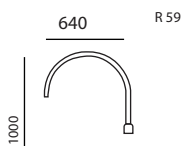
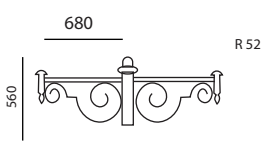
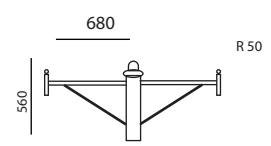
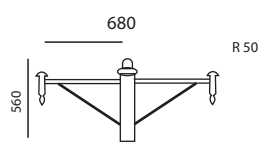
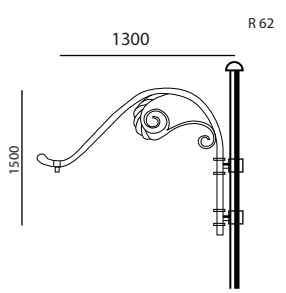
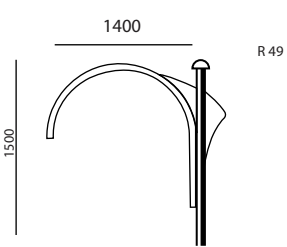
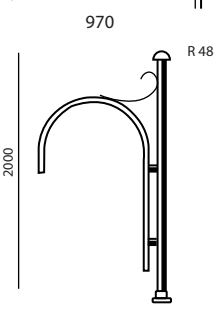
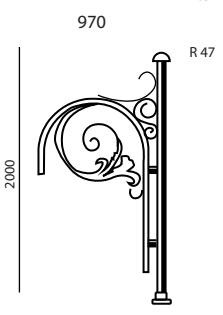
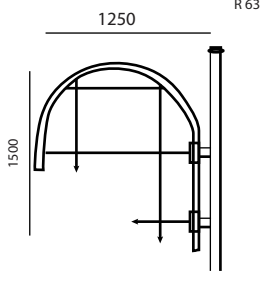
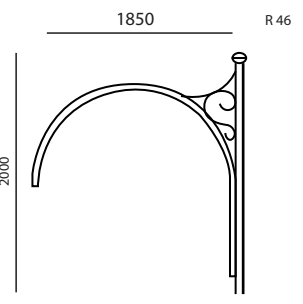
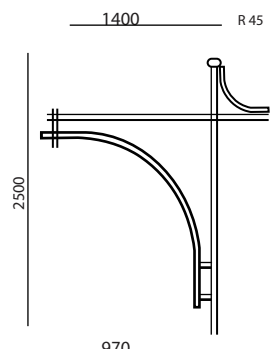
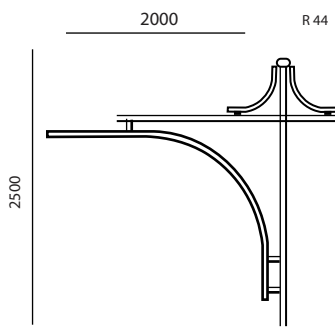
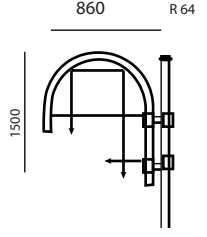
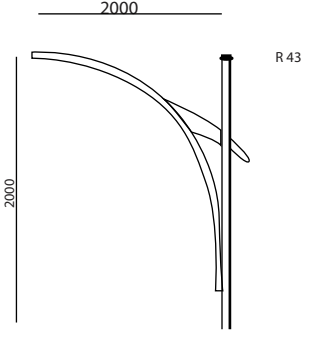
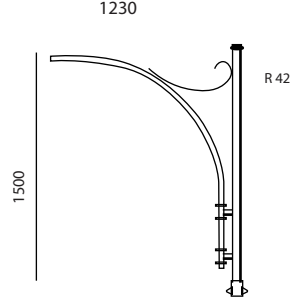
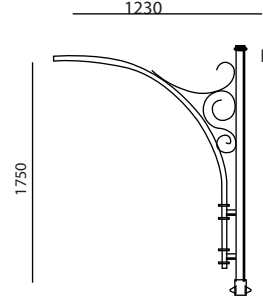
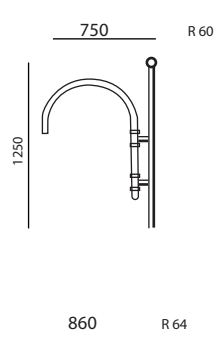
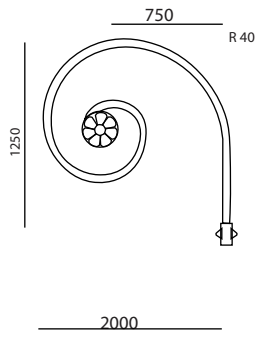
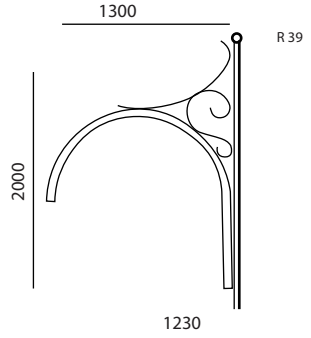
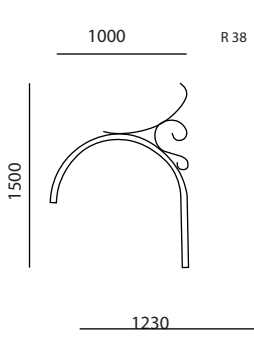
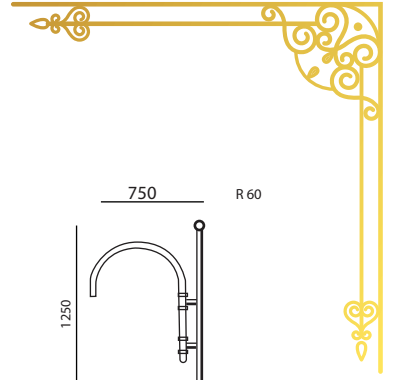
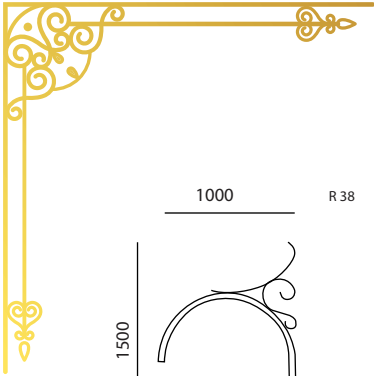

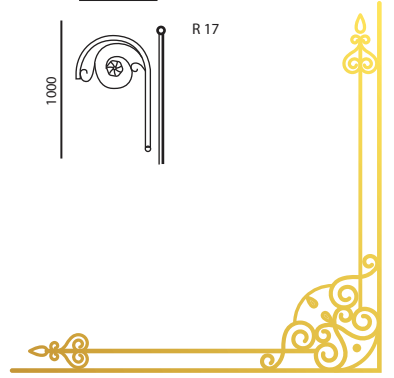
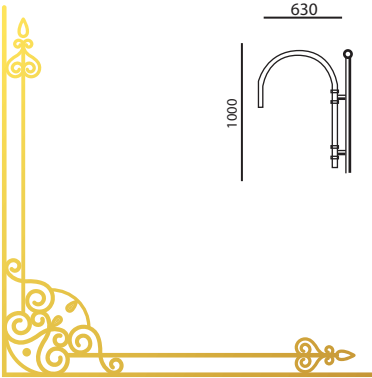
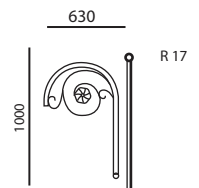
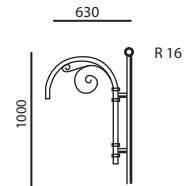
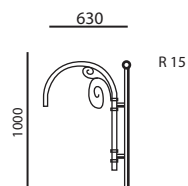
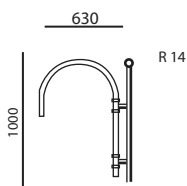
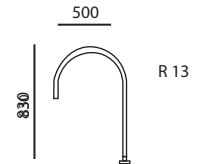
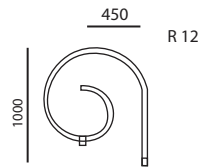
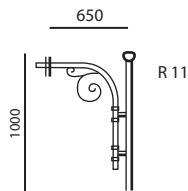
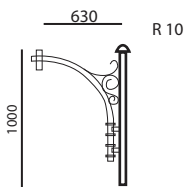
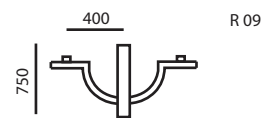
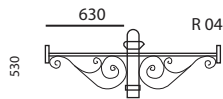
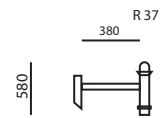
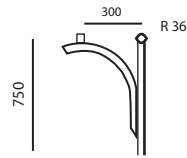
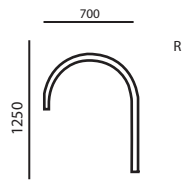
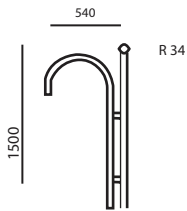
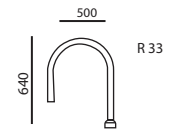
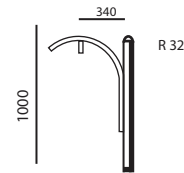
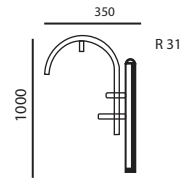
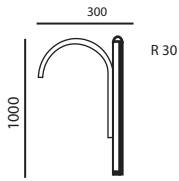
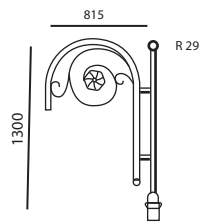
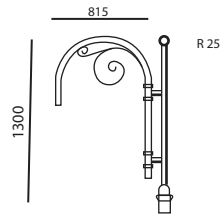
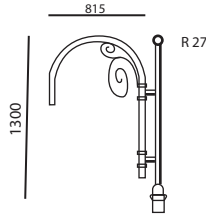
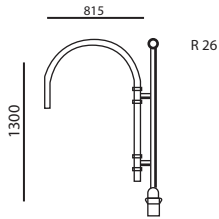
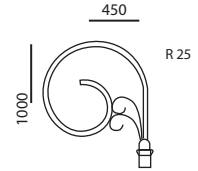
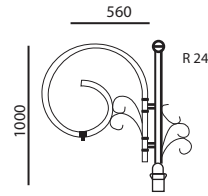
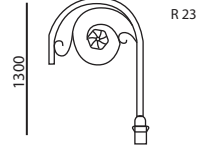
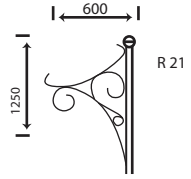
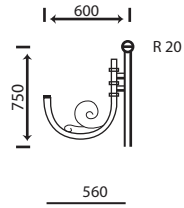
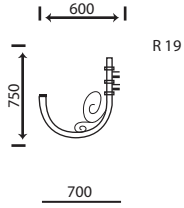
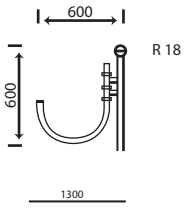
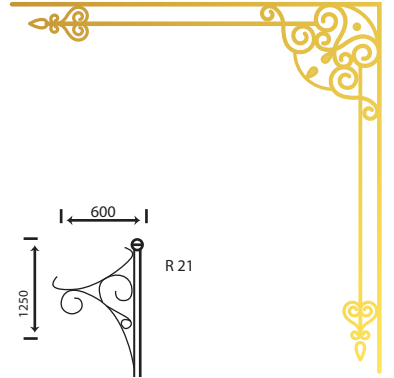
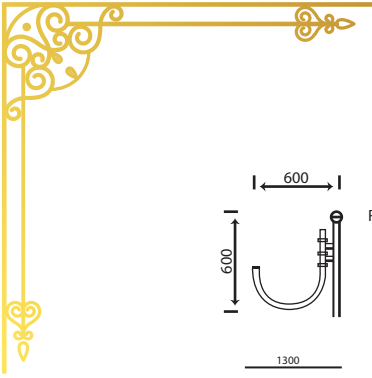

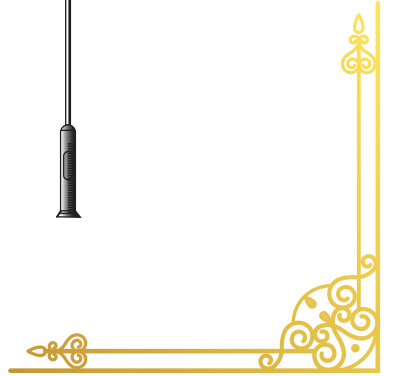
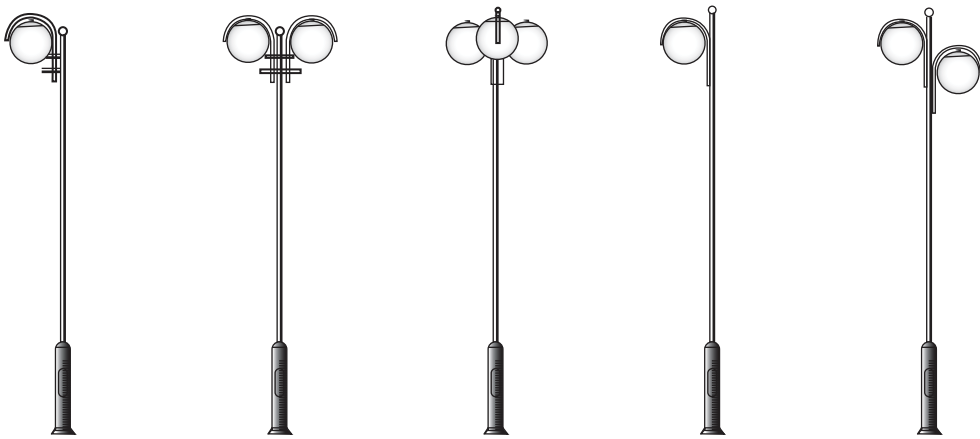
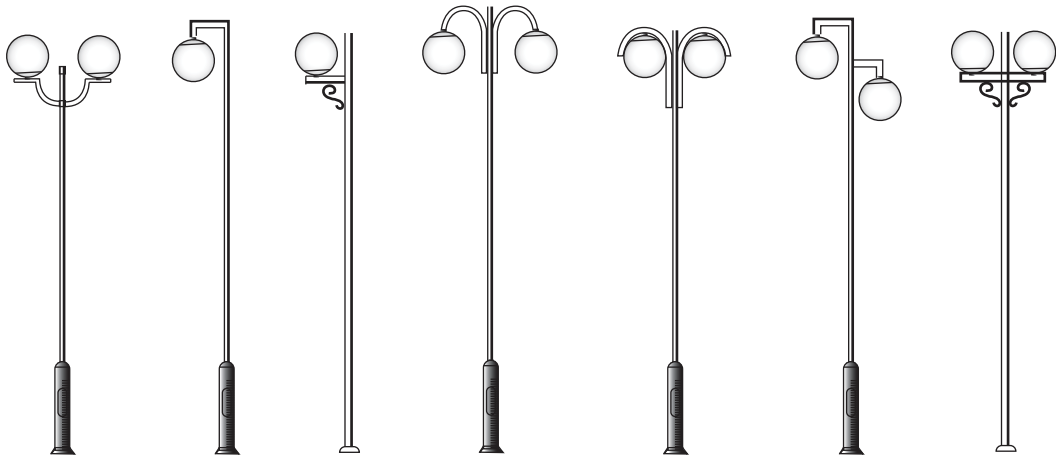
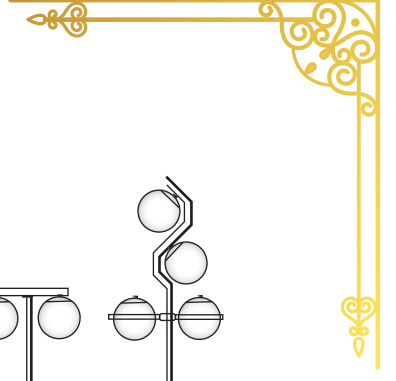
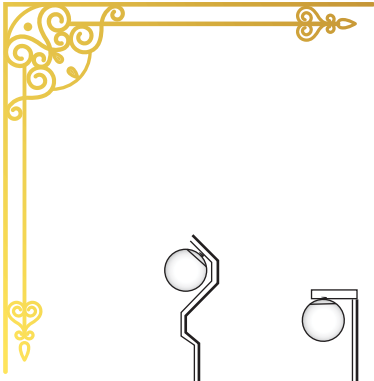

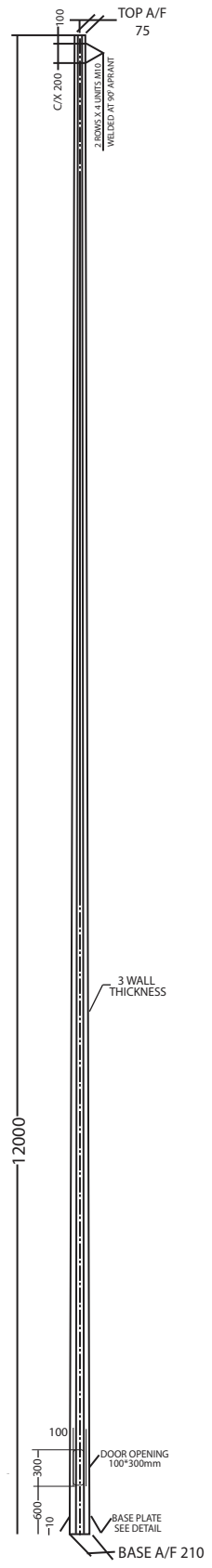
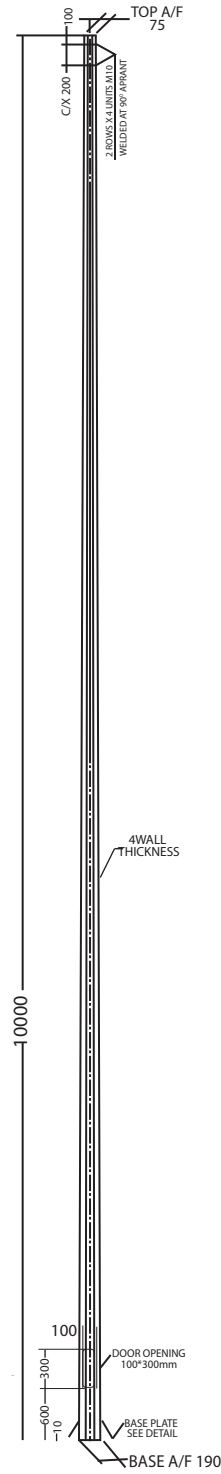
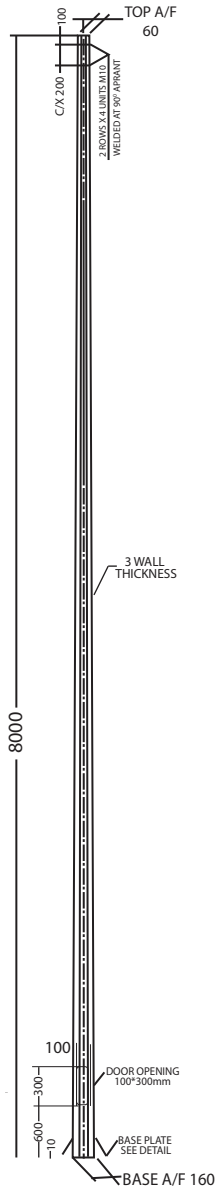
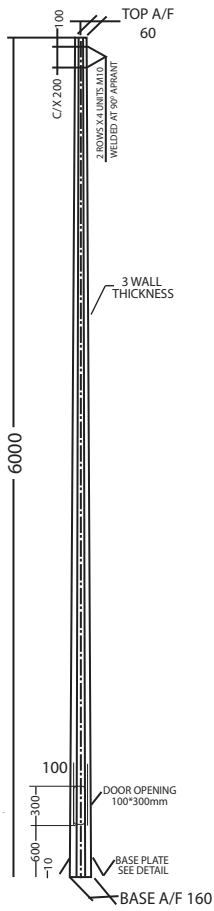



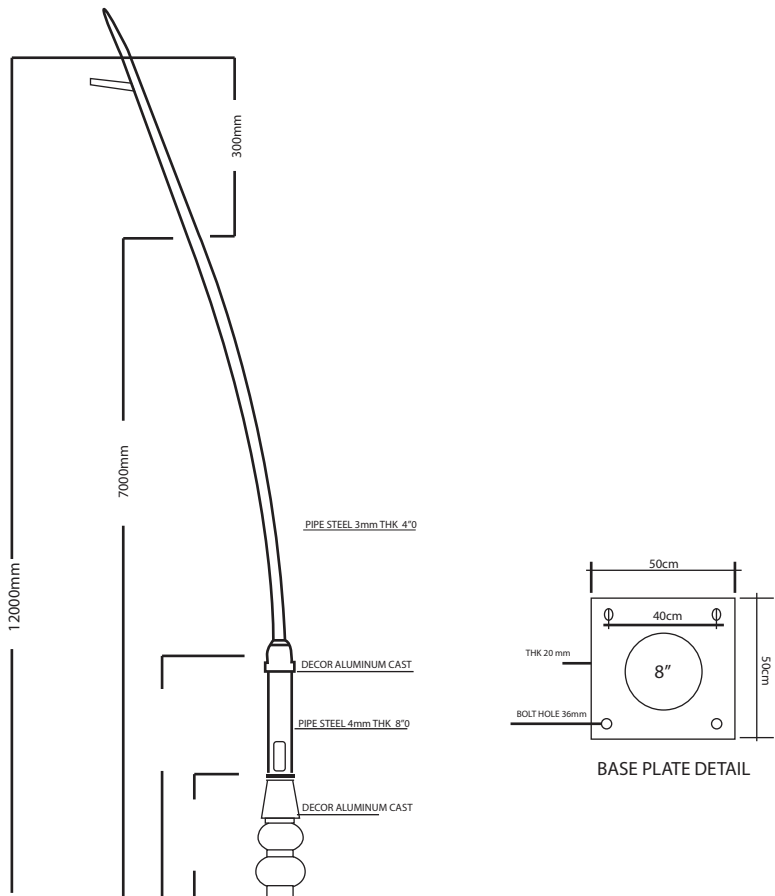
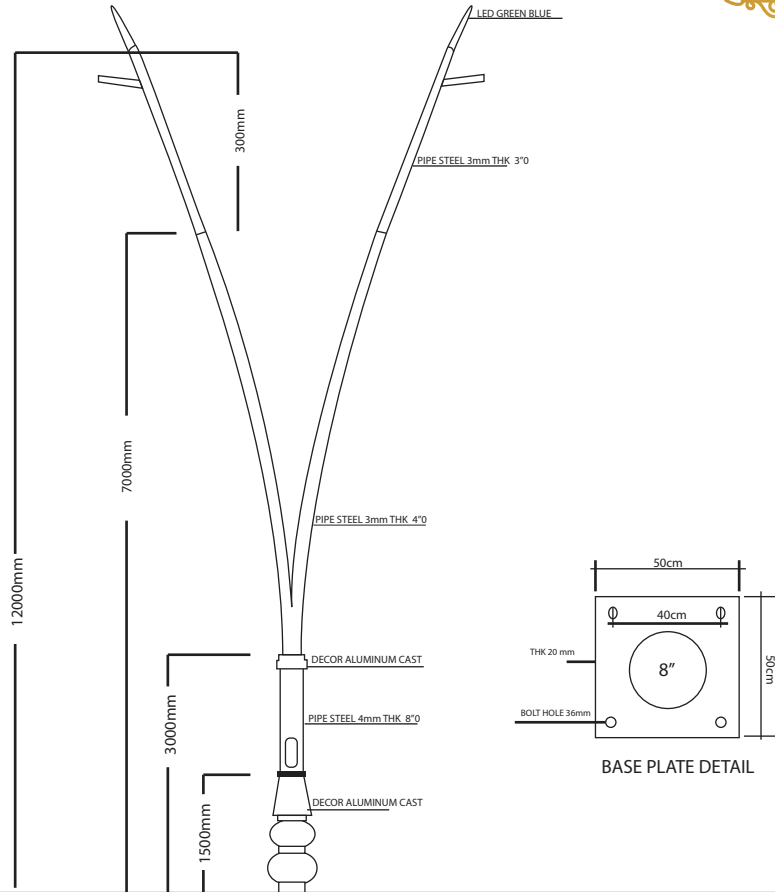

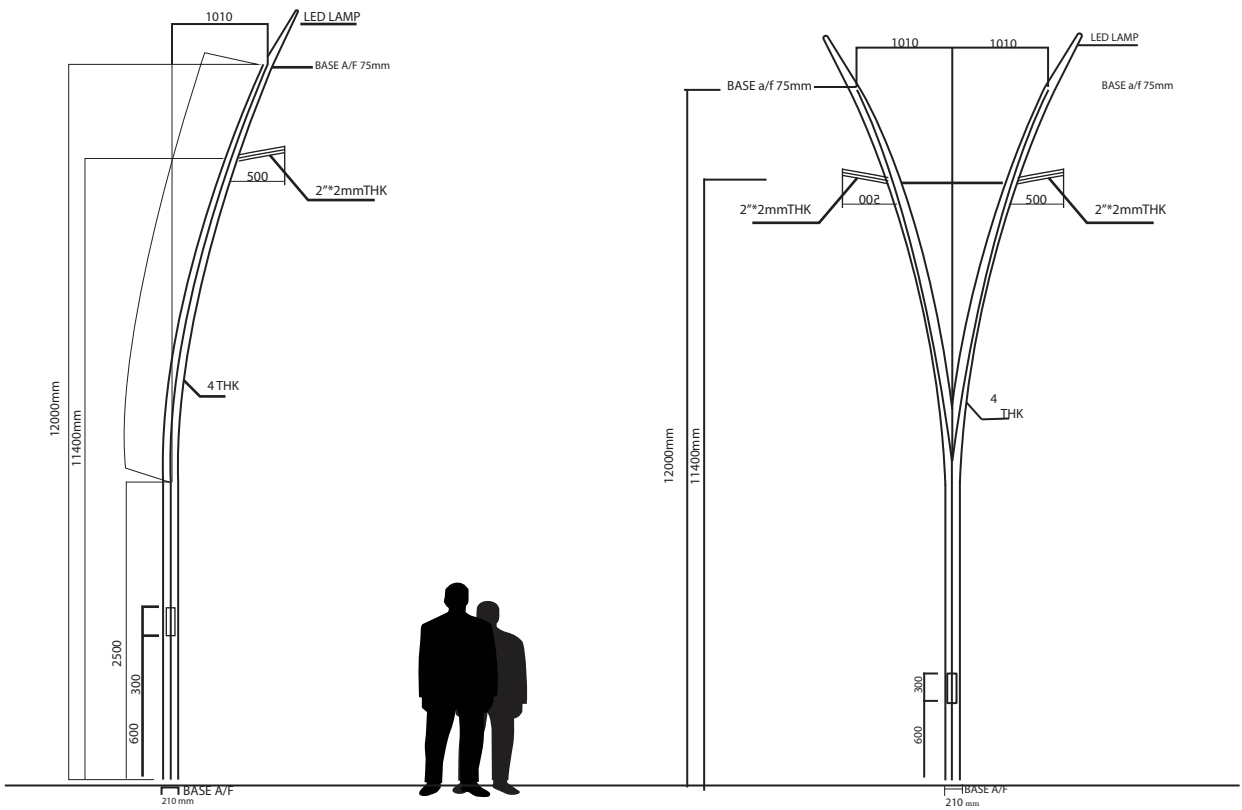
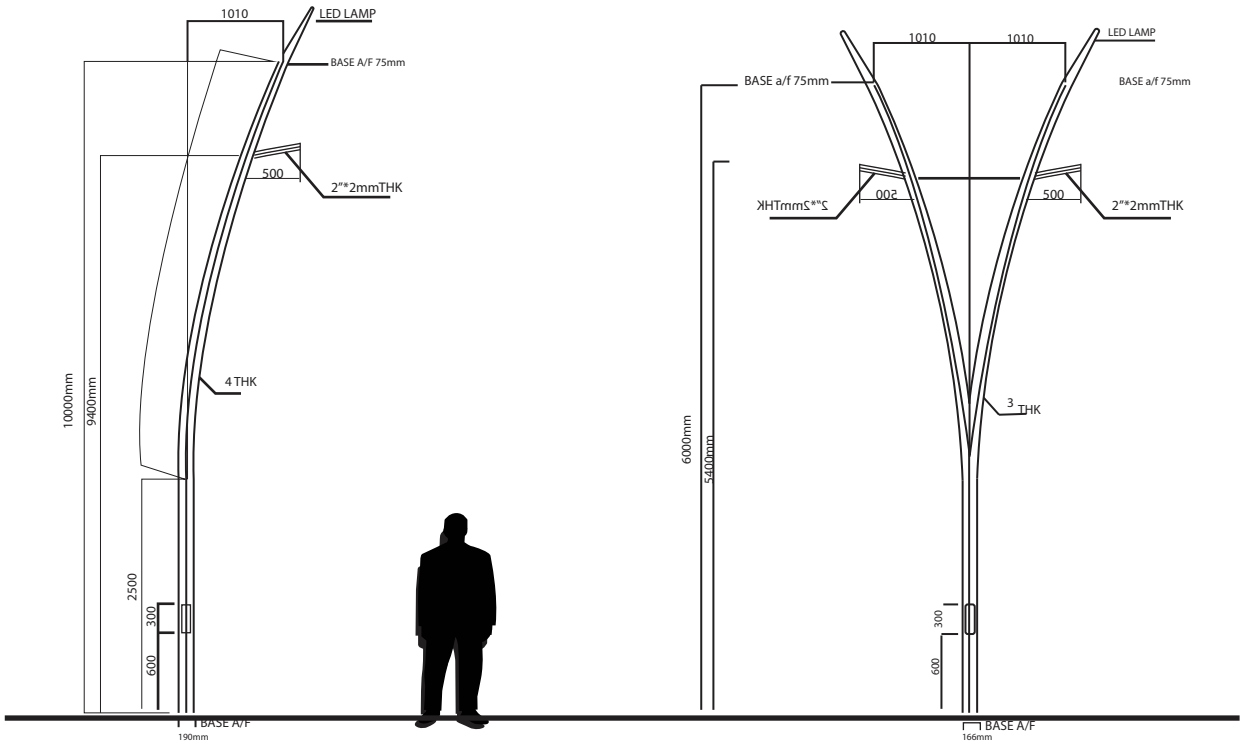

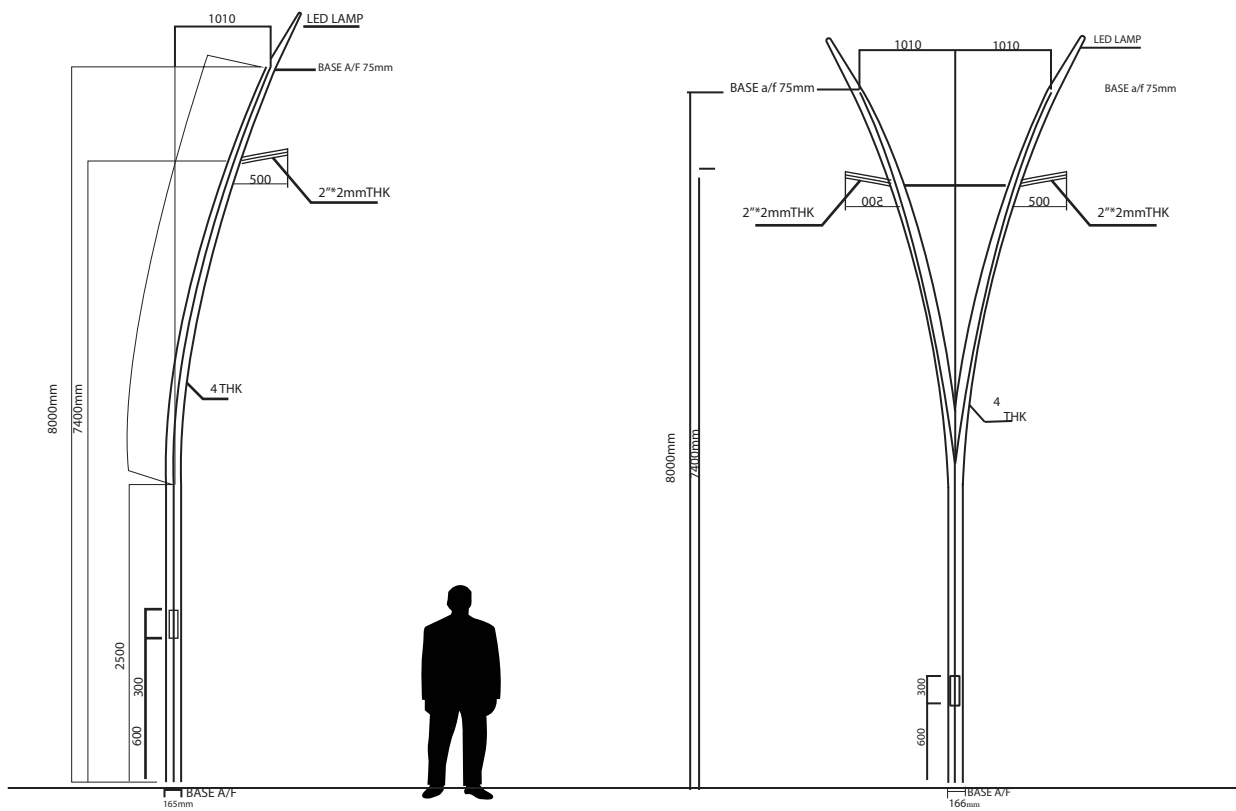
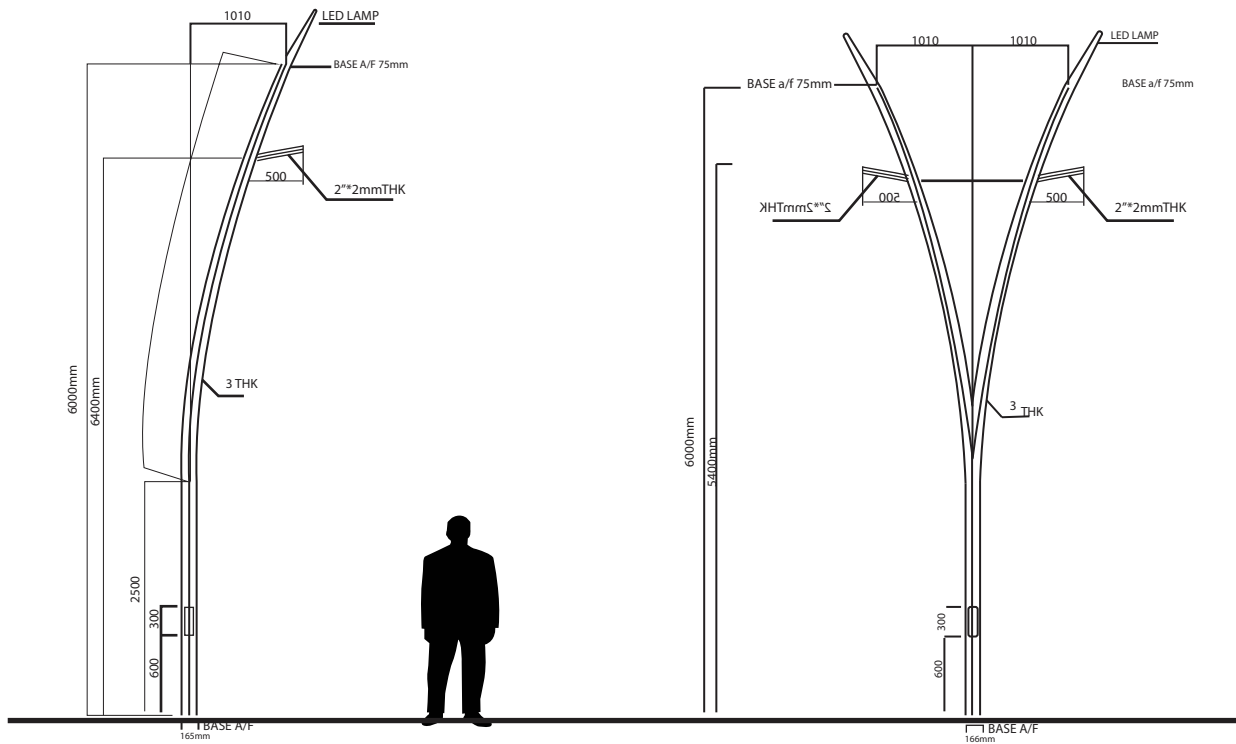

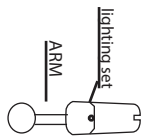
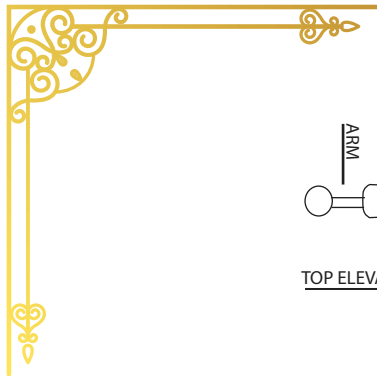

TOP ELEVATION

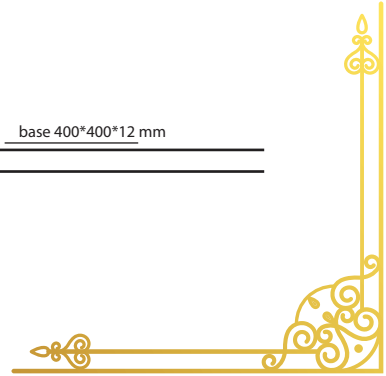
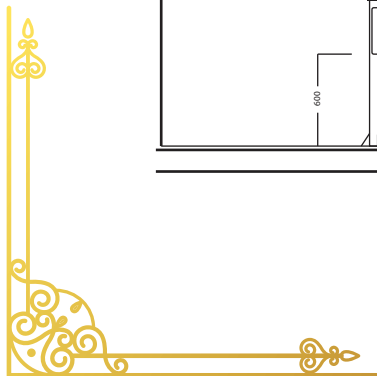
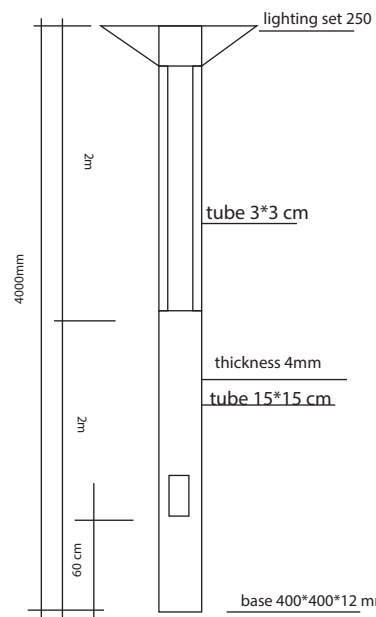
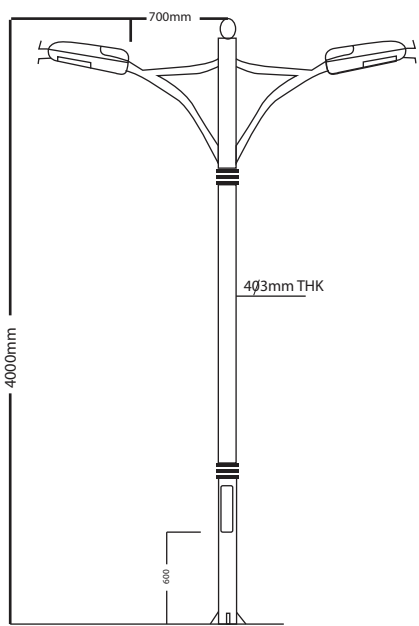
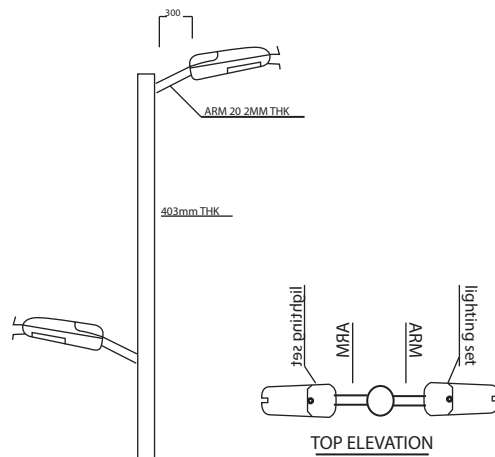
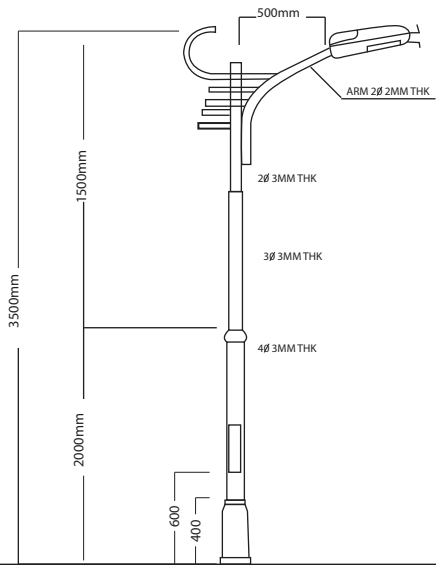

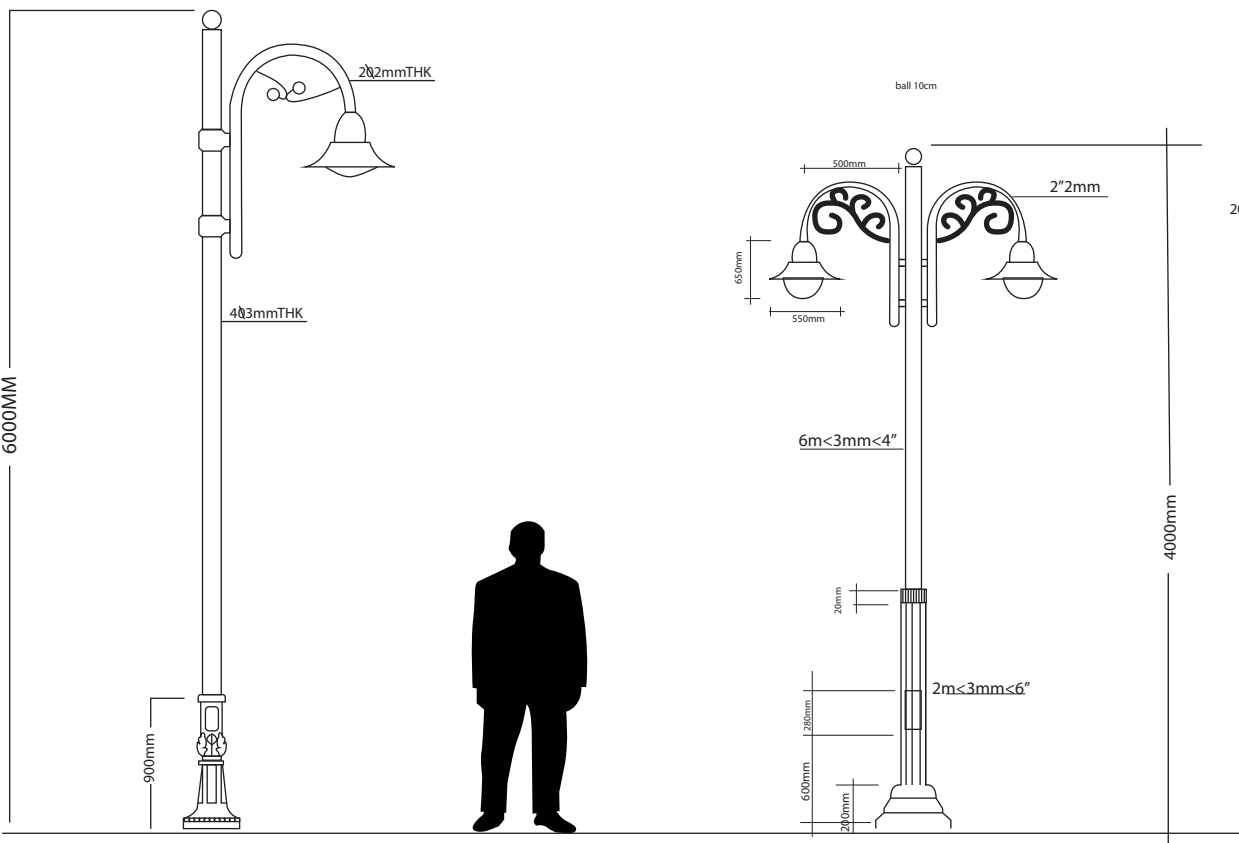
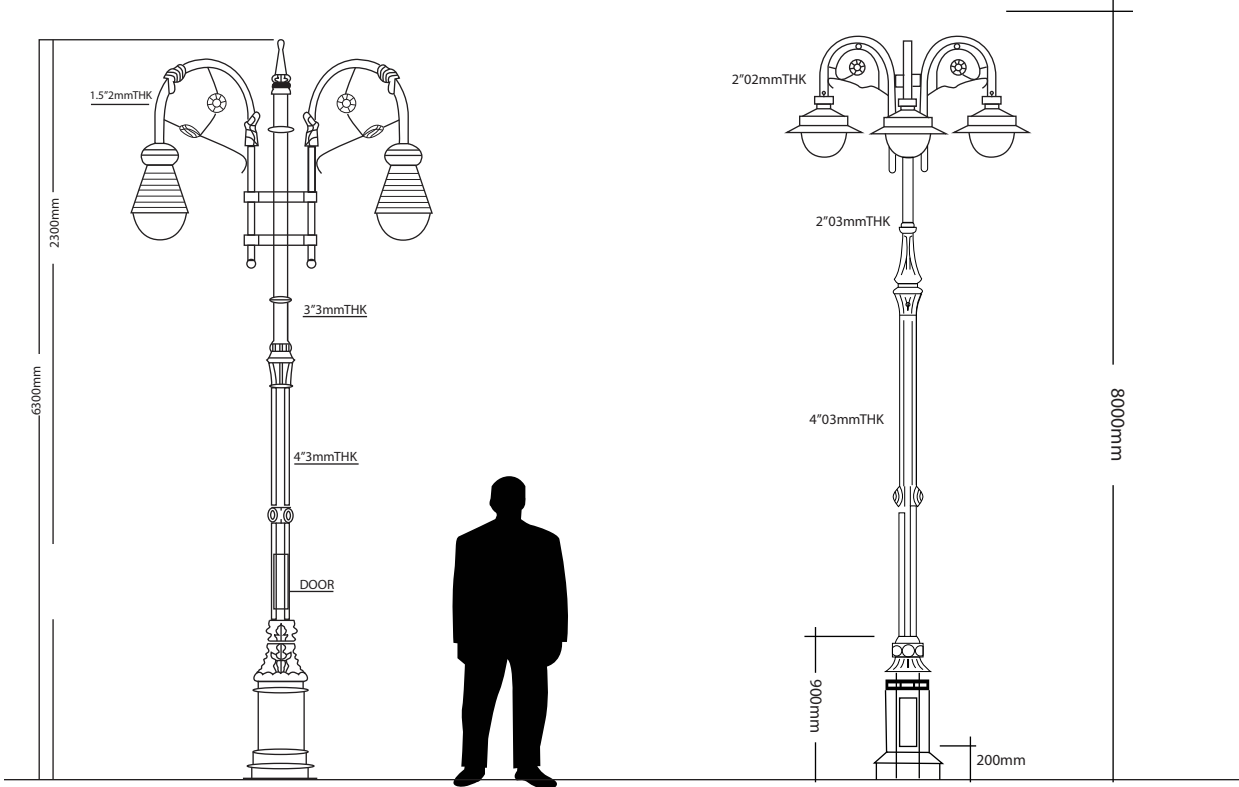

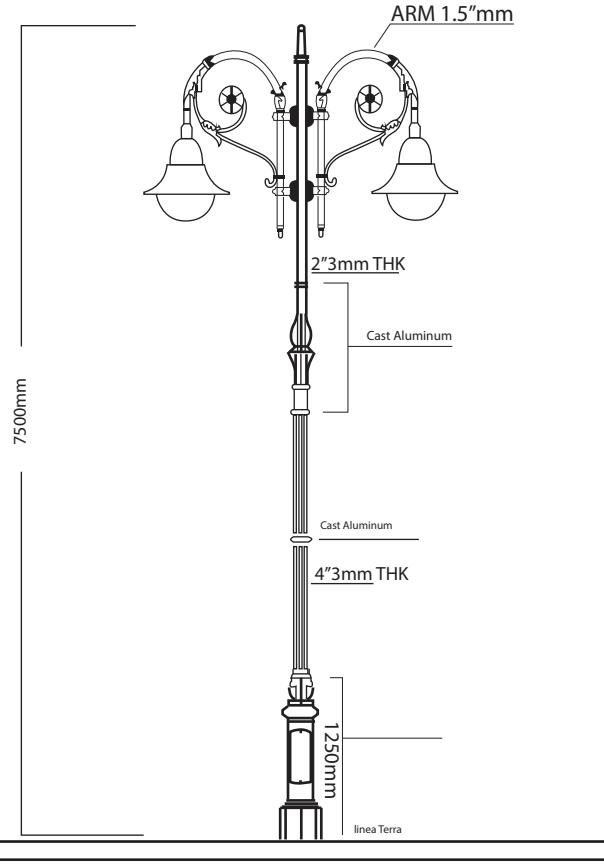
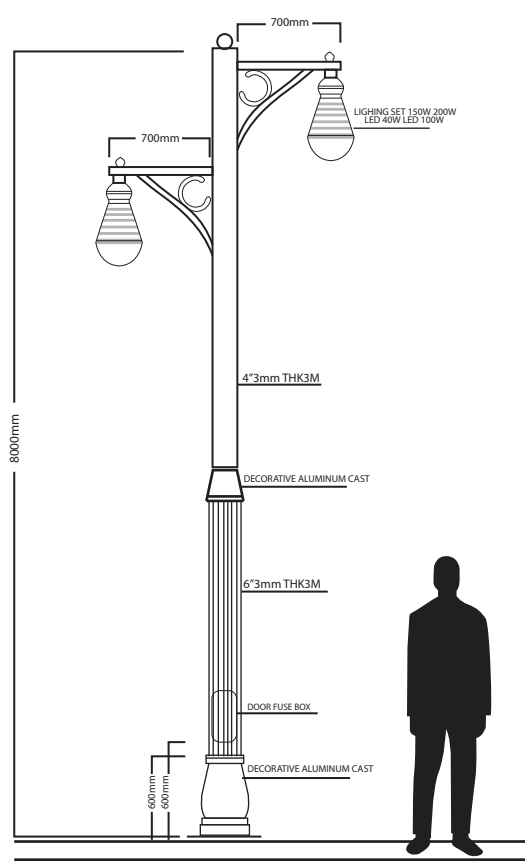
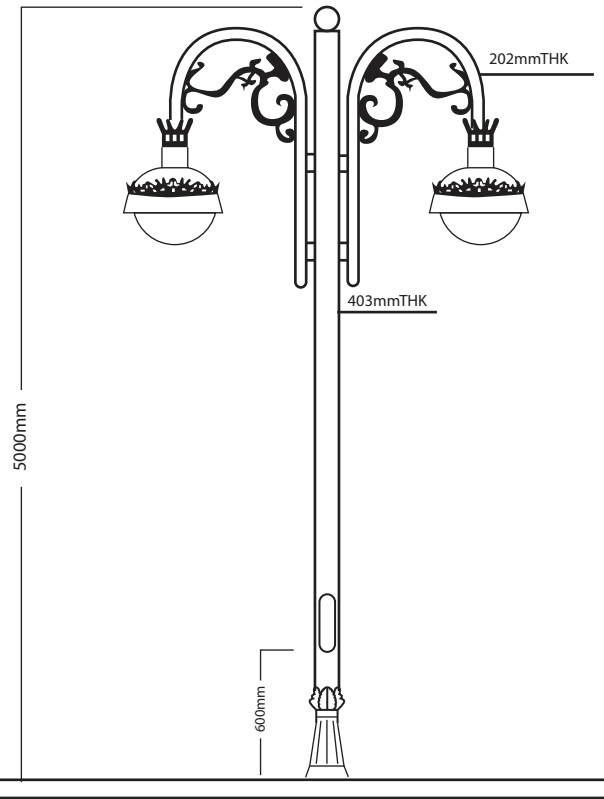
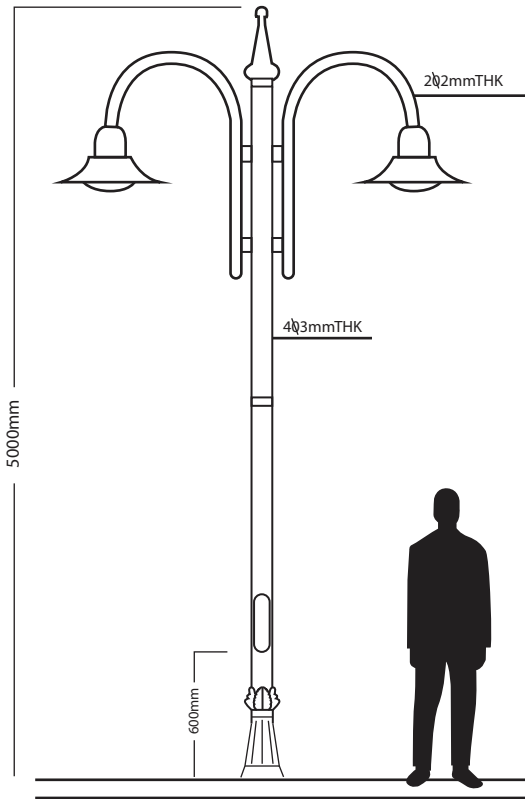

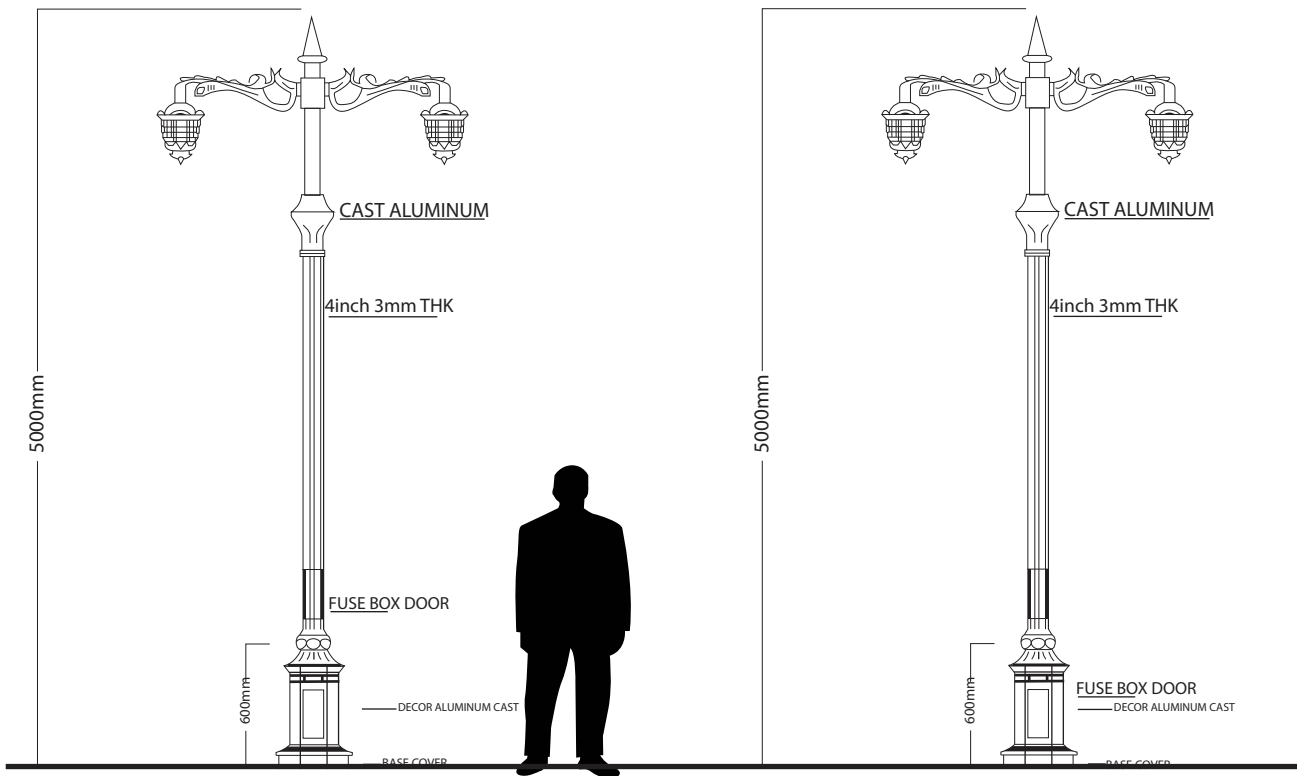
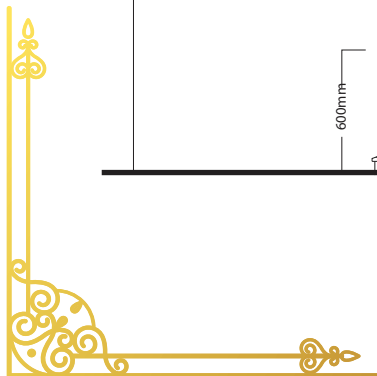
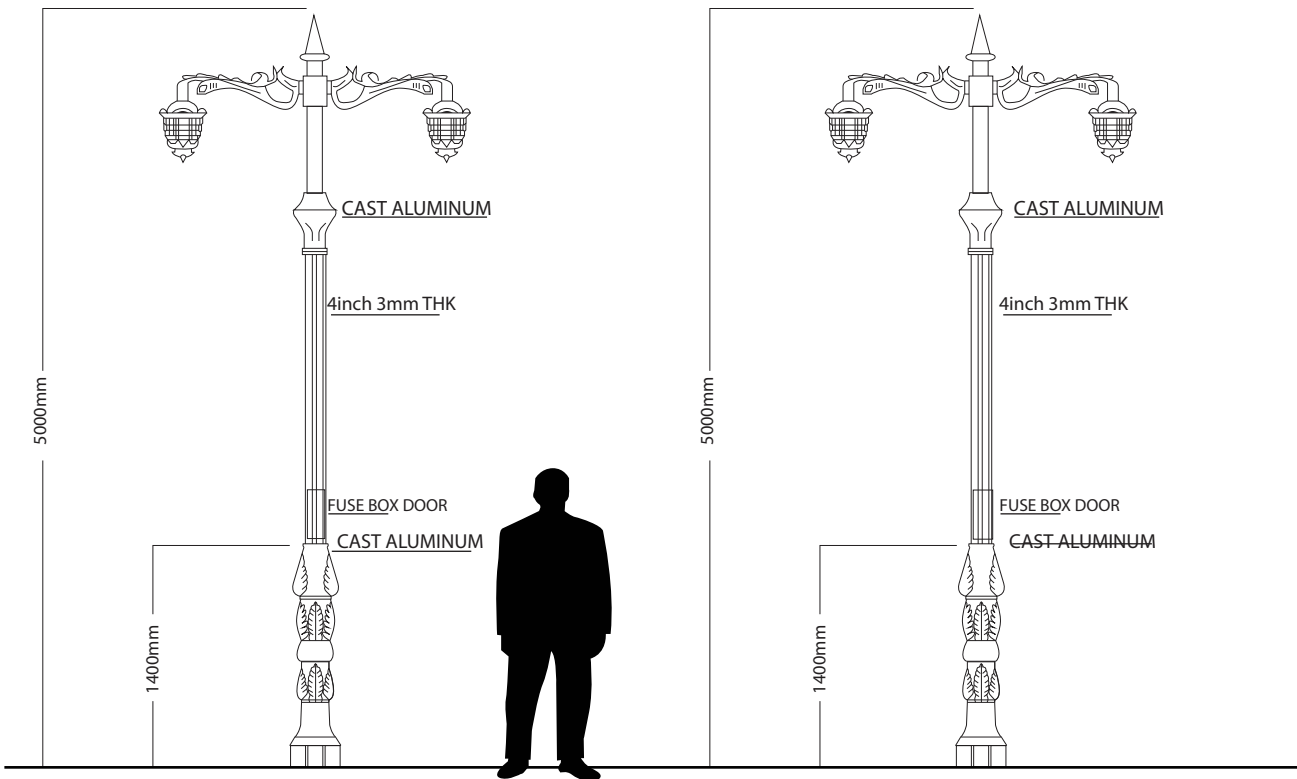
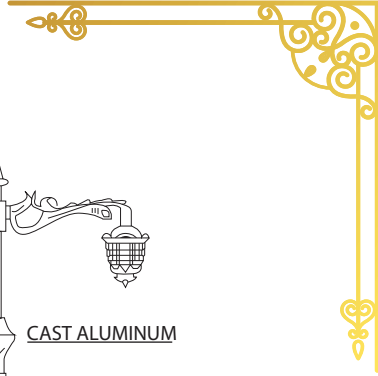
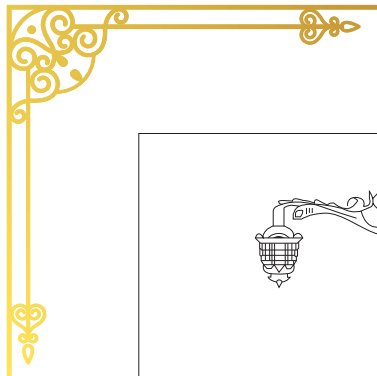



# GALLERY



































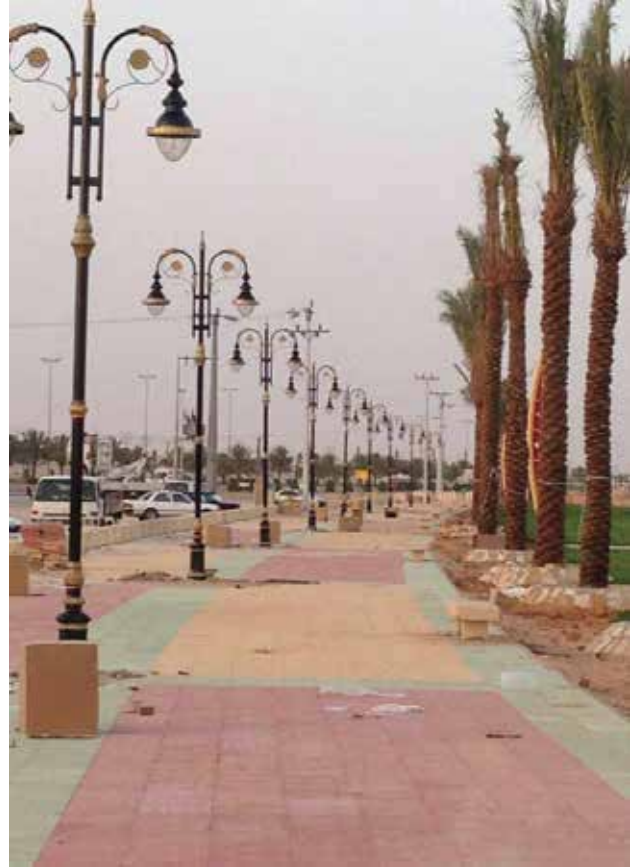





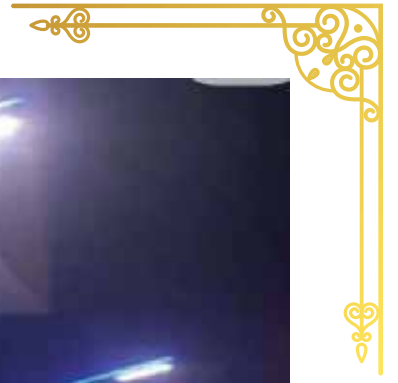
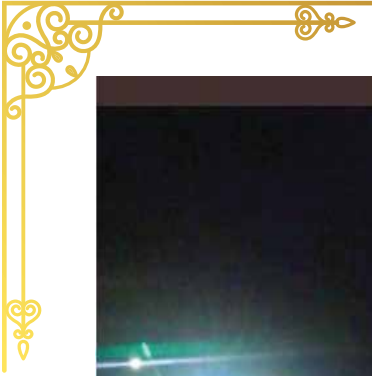







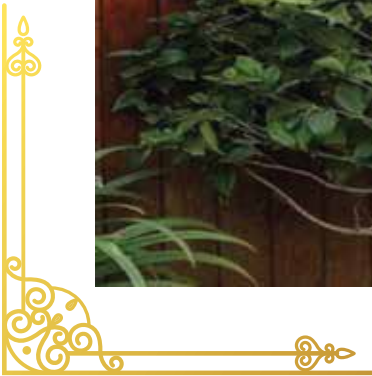



















# SOLAR LIGHTS



All one solar street light  
太阳能一体化路灯



Solar Street Lamp  
一体化太阳能灯



Solar Street Lamp  
一体化太阳能灯





365DAYS OF LIGHT  
微波感应 (8-12M)



Multifunctional Experience  
智能光控 自动开关



90°

随心调节角度方向

可根据实际需求调节角度方向，满足太阳能  
板理想光照角度需求



Aluminum profile strip induction series  
铝型材带感应系列

Solar Street Lamp  
365天亮灯  
户外防雨  
一体化太阳能路灯  
让灯光点亮生活









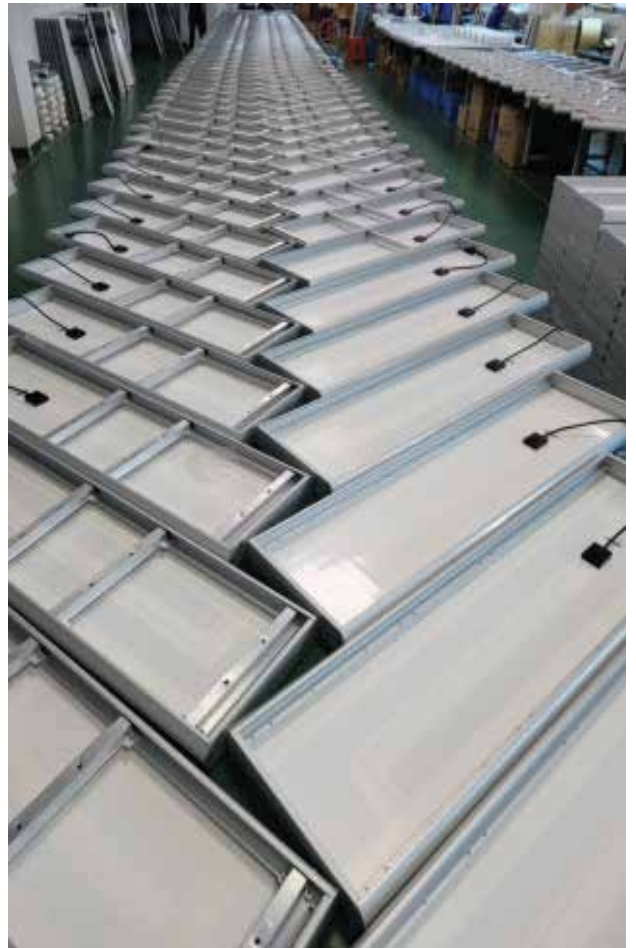

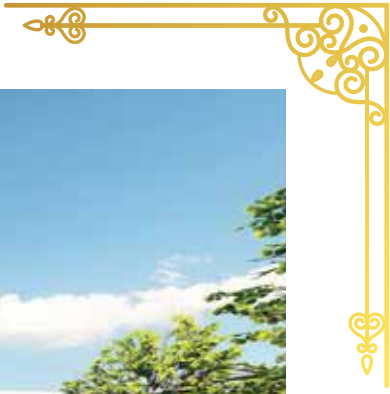
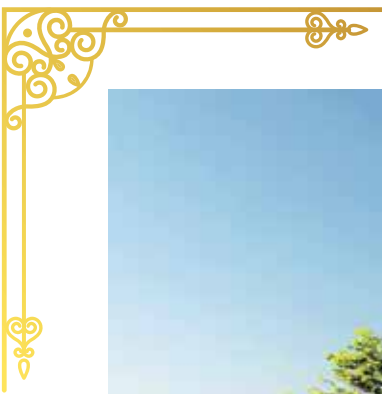



INTEGRATED SOLAR STREET LAMP

一体化太阳能路灯

SEGMENTED TIME CONTROL,  
AUTOMATIC SENSING



# COLORS CODES

# ALL Colour CODEs

							
1000 Green Beige	1001 Pale Beige	1002 Sand Yellow	1003 Signal Yellow	1004 Dark Golden Yellow	1005 Honey Yellow	1006 Maize Yellow	1007 Chrome Yellow
							
1011 Brown Beige	1012 Lemon Yellow	1013 Pearl White	1014 Dark Ivory	1015 Light Ivory	1016 Sulphur Yellow	1017 Saffron Yellow	1018 Zinc Yellow
							
1019 Grey Beige	1020 Olive Yellow	1021 Cadmium Yellow	1023 Traffic Yellow	1024 Ochre Yellow	1027 Curry Yellow	1028 Melon Yellow	1032 Broom Yellow
							
1033 Dahlia Yellow	1034 Pastel Yellow	2000 Yellow Orange	2001 Red Orange	2002 Vermillion	2003 Pastel Orange	2004 Pure Orange	2008 Light Red Orange
							
2009 Traffic Orange	2010 Signal Orange	2011 Deep Orange	2012 Salmon Orange	3000 Flame Red	3001 RAL Signal Red	3002 Carmine Red	3003 Ruby Red
							
3004 Purple Red	3005 Wine Red	3007 Black Red	3009 Oxide Red	3011 Brown Red	3012 Beige Red	3013 Tomato Red	3014 Antique Pink
							
3015 Light Pink	3016 Coral Red	3017 Rose	3018 Strawberry Red	3020 Traffic Red	3022 Dark Salmon Red	3027 Raspberry Red	3031 Orient Red
							
4001 Red Lilac	4002 Red Violet	4003 Heather Violet	4004 Claret Violet	4005 Blue Lilac	4006 Traffic Purple	4007 Purple Violet	4008 Signal Violet
							
4009 Pastel Violet	4010 Telemagenta	5000 Violet Blue	5001 Green Blue	5002 Ultramarine Blue	5003 dark Sapphire Blue	5004 Black Blue	5005 Signal Blue
							
5007 Brilliant Blue	5008 Grey Blue	5009 Light Azure Blue	5010 Gentian Blue	5011 Steel Blue	5012 Light Blue	5013 Dark Cobalt Blue	5014 Pigeon Blue
							
5015 Middle Sky Blue	5017 Traffic Blue	5018 Turkish Blue	5019 Capri Blue	5020 Ocean Blue	5021 Water Blue	5022 Night Blue	5023 Fern Blue
							
5024 Pastel Blue	6000 Patina Green	6001 Middle Emerald Green	6002 Leaf Green	6003 Middle Olive Green	6004 Blue Green	6005 Light Moss Green	6006 Grey Olive



7008 Khaki Grey	7009 Green Grey	7010 Tarpaulin Grey	7011 Iron Grey	7012 Basalt Grey	7013 Brown Grey	7015 Slate Grey	7016 Anthracite Grey
7021 Black Grey	7022 Umber Grey	7023 Concrete Grey	7024 Graphite Grey	7026 Granite Grey	7030 Stone Grey	7031 Blue Grey	7032 Grey
7033 Cement Grey	7034 Yellow Grey	7035 Pale Grey	7036 Platinum Grey	7037 Dusty Grey	7038 Agate Grey	7039 Quartz Grey	7040 Window Grey
7042 Traffic Grey A	7043 Traffic Grey B	7044 Silky Grey	7045 Telegrey 1	7046 Telegrey 2	7047 Telegrey 4	8000 Green Brown	8001 Gold Brown
8002 Signal Brown	8003 Clay Brown	8004 Copper Brown	8007 Fawn Brown	8008 Olive Brown	8011 Nut Brown	8012 Red Brown	8014 Sepia Brown
8015 Chestnut Brown	8016 Mahogany Brown	8017 Chocolate Brown	8019 Grey Brown	8022 Black Brown	8023 Orange Brown	8024 Beige Brown	8025 Pale Brown
8028 Earth Brown	9001 Cream	9002 Grey White	9003 Signal White	9004 Signal Black	9005 Jet Black	9010 Pure White	9011 Graphite Black
9016 Traffic White	9017 Traffic Black	9018 Papyrus White	7002 Olive Grey	7003 Moss Grey	7004 Signal Grey	7005 Mouse Grey	7006 Beige Grey
6007 Bottle Green	6008 Brown Green	6009 Fir Green	6010 Middle Grass Green	6011 Reseda Green	6012 Black Green	6013 Reed Green	6014 Yellow Olive
6015 Black Olive	6016 Turquoise Green	6017 May Green	6018 Yellow Green	6019 Pastel Green	6020 Chrome Green	6021 Pale Green	6022 Brown Olive
6024 Traffic Green	6025 Bracken Green	6026 Opal Green	6027 Turkish Green	6028 Pine Tree Green	6029 Mint Green	6032 Signal Green	6033 Turquoise Blue
6034 Pale Turquoise	7000 Dark Squirrel Grey	7001 Silver Grey					



ورشة السراج المنير للحداثة  
ALSIRAJ ALMUNIR METAL FABRICATION WORKS



شركاؤكم في النجاح



info@alsirajalmunir.com  
www.alsirajalmunir.com



+966 502 86 3503  
+966 502 21 1015